



ST54F THRU ST510F

Reverse Voltage - 40 to 100 Volts Forward Current - 5.0 Ampere

SURFACE MOUNT TRENCH SCHOTTKY RECTIFIER

Features

- ◆ The plastic package carries Underwriters Laboratory Flammability Classification 94V-0
- ◆ For surface mounted applications
- ◆ Metal silicon junction, majority carrier conduction
- ◆ Low power loss, high efficiency
- ◆ Built-in strain relief, ideal for automated placement
- ◆ High forward surge current capability
- ◆ High temperature soldering guaranteed: 260°C/10 seconds at terminals

SMAF

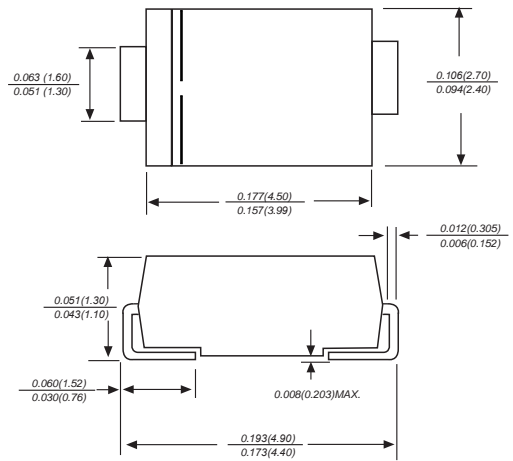

Dimensions in inches and (millimeters)

Mechanical Data

Case : JEDEC DO-214AC/SMA Molded plastic body

Terminals : Solder plated, solderable per MIL-STD-750, Method 2026

Polarity : Polarity symbol marking on body

Mounting Position : Any

Weight : 0.0018ounce, 0.064 grams

Maximum Ratings And Electrical Characteristics

Ratings at 25°C ambient temperature unless otherwise specified.

Single phase half-wave 60Hz, resistive or inductive load, for capacitive load current derate by 20%.

Parameter	SYMBOLS	ST54F	ST56F	ST510F	UNITS
		MDD ST54F	MDD S56F	MDD ST510F	
Maximum repetitive peak reverse voltage	V_{RRM}	40	60	100	V
Maximum RMS voltage	V_{RMS}	28	42	70	V
Maximum DC blocking voltage	V_{DC}	40	60	100	V
Maximum average forward rectified current at TL (see fig. 1)	$I_{(AV)}$	5.0			A
Peak forward surge current 8.3ms single half sine-wave superimposed on rated load (JEDEC Method)	I_{FSM}	100	80		A
Maximum instantaneous forward voltage at 5.0A	V_F	0.43	0.50	0.60	V
Maximum DC reverse current at rated DC blocking voltage $T_A=25^\circ\text{C}$ $T_A=125^\circ\text{C}$	I_R	0.10	0.05	0.03	mA
		20.0			
Typical junction capacitance (NOTE 1)	C_J	500			pF
Typical thermal resistance (NOTE 2)	$R_{\theta JA}$	80.0			°C/W
Operating junction temperature range	T_J	-55 to +125	-55 to +150		°C
Operating storage temperature range	T_{STG}	-55 to +150			°C

Note: 1. Measured at 1MHz and applied reverse voltage of 4.0V D.C.

2. Thermal resistance from junction to ambient at 0.375" (9.5mm) lead length, P.C.B. mounted



ST54F THRU ST510F

Reverse Voltage - 40 to 100 Volts Forward Current - 5.0 Ampere

Ratings And Characteristic Curves

AVERAGE FORWARD RECTIFIED CURRENT, AMPERES

FIG. 1- FORWARD CURRENT DERATING CURVE

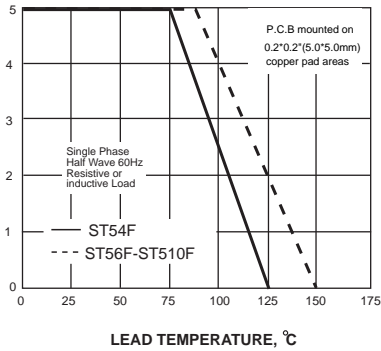

PEAK FORWARD SURGE CURRENT, AMPERES

FIG. 2-MAXIMUM NON-REPETITIVE PEAK FORWARD SURGE CURRENT

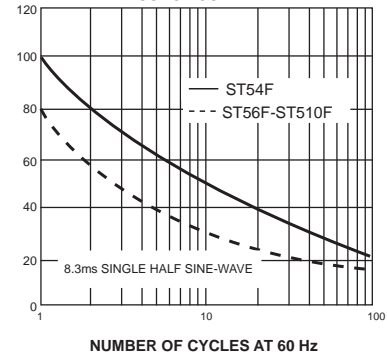
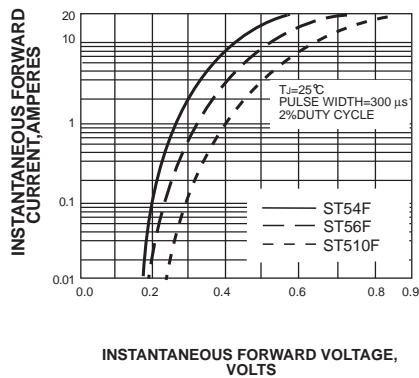

FIG. 3-TYPICAL INSTANTANEOUS FORWARD CHARACTERISTICS



INSTANTANEOUS REVERSE CURRENT, MILLIAMPERES

FIG. 4-TYPICAL REVERSE CHARACTERISTICS

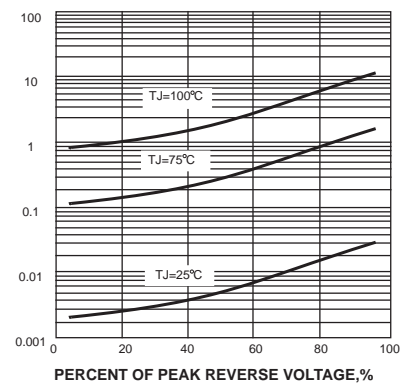
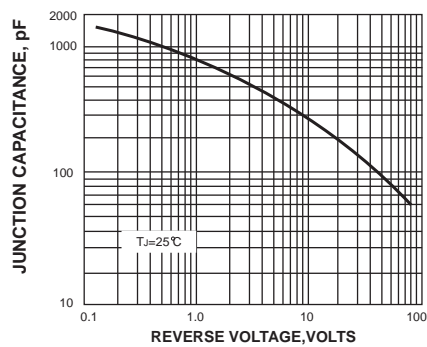
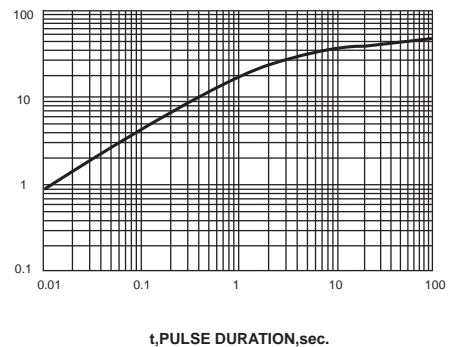

FIG. 5-TYPICAL JUNCTION CAPACITANCE



TRANSIENT THERMAL IMPEDANCE, °C/W

FIG. 6-TYPICAL TRANSIENT THERMAL IMPEDANCE



The curve above is for reference only.



ST54F THRU ST510F

Reverse Voltage - 40 to 100 Volts Forward Current - 3.0 Ampere

Packing information

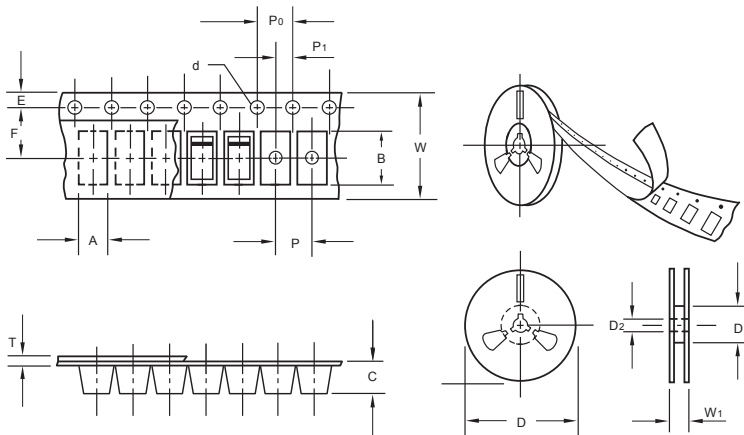

unit:mm

Item	Symbol	Tolerance	SMAF
Carrier width	A	0.1	2.80
Carrier length	B	0.1	4.75
Carrier depth	C	0.1	1.42
Sprocket hole	d	0.05	1.50
7" Reel outside diameter	D	2.0	178.00
7" Reel inner diameter	D ₁	min	54.40
Feed hole diameter	D ₂	0.5	13.00
Sprocket hole position	E	0.1	1.75
Punch hole position	F	0.1	5.05
Punch hole pitch	P	0.1	4.00
Sprocket hole pitch	P ₀	0.1	4.00
Embossment center	P ₁	0.1	2.00
Overall tape thickness	T	0.1	0.30
Tape width	W	0.3	8.00
Reel width	W ₁	1.0	12.30

Note: Devices are packed in accordance with EIA standard RS-481-A and specifications listed above.

Reel packing

PACKAGE	REEL SIZE	REEL (pcs)	COMPONENT SPACING (m/m)	BOX (pcs)	INNER BOX (m/m)	REEL DIA, (m/m)	CARTON SIZE (m/m)	CARTON (pcs)	APPROX. GROSS WEIGHT (kg)
SMAF	7"	3,000	4.0	6,000	210*208*203	178	400*265*400	120,000	10.0

Suggested Pad Layout

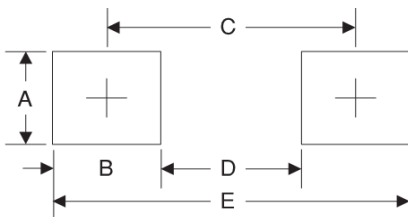

Symbol	Unit (mm)	Unit (inch)
A	1.8	0.071
B	1.6	0.063
C	3.8	0.150
D	2.2	0.087
E	5.4	0.213