



ST54A THRU ST510A

Reverse Voltage - 40 to 100 Volts Forward Current - 5.0 Ampere

SURFACE MOUNT TRENCH SCHOTTKY RECTIFIER

Features

- ◆ The plastic package carries Underwriters Laboratory Flammability Classification 94V-0
- ◆ For surface mounted applications
- ◆ Metal silicon junction, majority carrier conduction
- ◆ Low power loss, high efficiency
- ◆ Built-in strain relief, ideal for automated placement
- ◆ High forward surge current capability
- ◆ High temperature soldering guaranteed:
260°C/10 seconds at terminals

Mechanical Data

Case : JEDEC DO-214AC/SMA Molded plastic body

Terminals : Solder plated, solderable per MIL-STD-750, Method 2026

Polarity : Polarity symbol marking on body

Mounting Position : Any

Weight : 0.002ounce, 0.07 grams

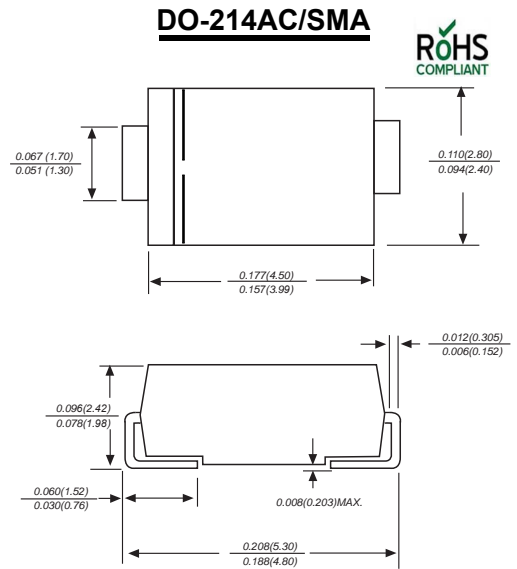

Dimensions in inches and (millimeters)

Maximum Ratings And Electrical Characteristics

Ratings at 25°C ambient temperature unless otherwise specified.

Single phase half-wave 60Hz, resistive or inductive load, for capacitive load current derate by 20%.

Parameter	SYMBOLS	ST54A	ST56A	ST510A	UNITS
Marking Code		MDD ST54A	MDD ST56A	MDD ST510A	
Maximum repetitive peak reverse voltage	V_{RRM}	40	60	100	V
Maximum RMS voltage	V_{RMS}	28	42	70	V
Maximum DC blocking voltage	V_{DC}	40	60	100	V
Maximum average forward rectified current at TL (see fig. 1)	$I_{(AV)}$	5.0			A
Peak forward surge current 8.3ms single half sine-wave superimposed on rated load (JEDEC Method)	I_{FSM}	100	80		A
Maximum instantaneous forward voltage at 5.0A	V_F	0.43	0.50	0.60	V
Maximum DC reverse current $T_A=25^\circ\text{C}$ at rated DC blocking voltage $T_A=125^\circ\text{C}$	I_R	0.10	0.05	0.03	mA
		20.0		10.0	
Typical junction capacitance (NOTE 1)	C_J	500			pF
Typical thermal resistance (NOTE 2)	$R_{\theta JA}$	80.0			°C/W
Operating junction temperature range	T_J	-55 to +125	-55 to +150		°C
Operating storage temperature range	T_{STG}	-55 to +150			°C

Note: 1. Measured at 1MHz and applied reverse voltage of 4.0V D.C.

2. Thermal resistance from junction to ambient at 0.375" (9.5mm) lead length, P.C.B. mounted



ST54A THRU ST510A

Reverse Voltage - 40 to 100 Volts Forward Current - 5.0 Ampere

Ratings And Characteristic Curves

AVERAGE FORWARD RECTIFIED CURRENT, AMPERES

FIG. 1- FORWARD CURRENT DERATING CURVE

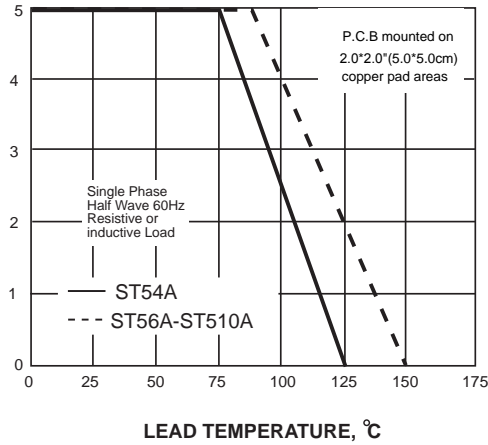

PEAK FORWARD SURGE CURRENT, AMPERES

FIG. 2-MAXIMUM NON-REPETITIVE PEAK FORWARD SURGE CURRENT

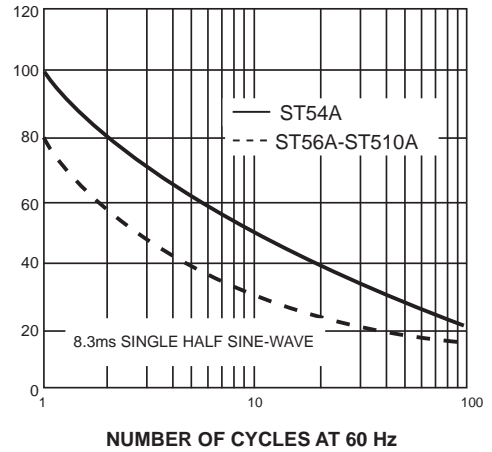

FIG. 3-TYPICAL INSTANTANEOUS FORWARD CHARACTERISTICS

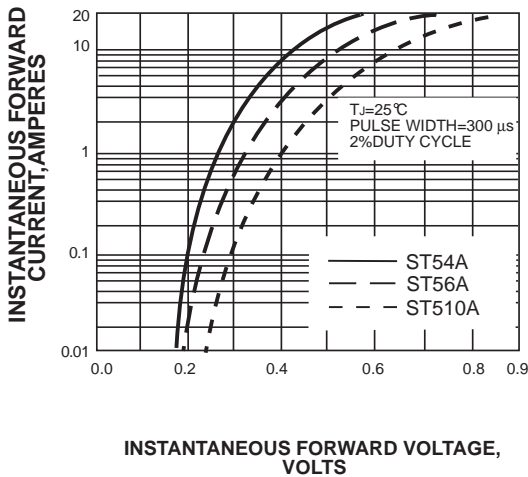

FIG. 4-TYPICAL REVERSE CHARACTERISTICS

INSTANTANEOUS REVERSE CURRENT, MILLIAMPERES

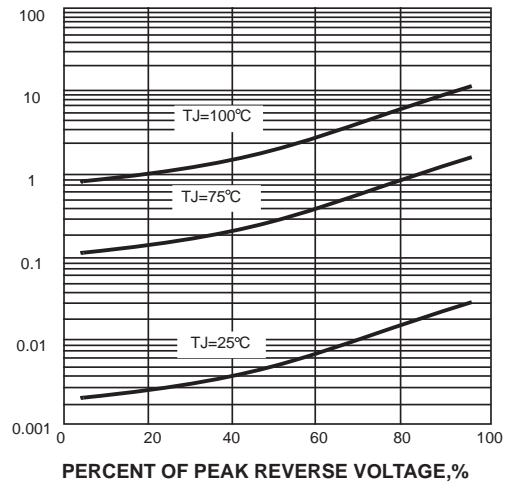
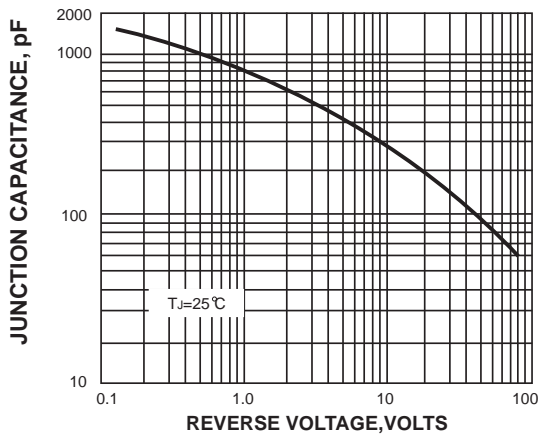
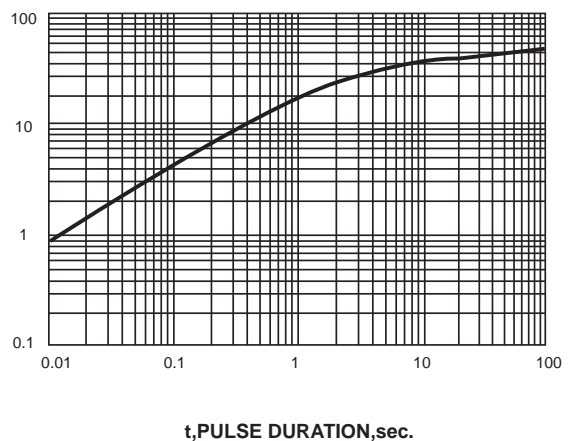

FIG. 5-TYPICAL JUNCTION CAPACITANCE



TRANSIENT THERMAL IMPEDANCE, °C/W

FIG. 6-TYPICAL TRANSIENT THERMAL IMPEDANCE



The curve above is for reference only.



ST54A THRU ST510A

Reverse Voltage - 40 to 100 Volts Forward Current - 5.0 Ampere

Packing information

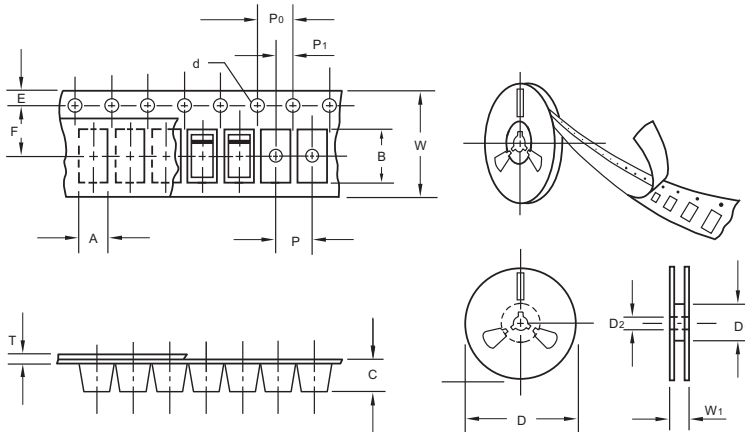

Item	Symbol	Tolerance	SMA
Carrier width	A	0.1	2.80
Carrier length	B	0.1	5.33
Carrier depth	C	0.1	2.36
Sprocket hole	d	0.05	1.50
13" Reel outside diameter	D	2.0	330.00
13" Reel inner diameter	D ₁	min	50.00
7" Reel outside diameter	D	2.0	178.00
7" Reel inner diameter	D ₁	min	62.00
Feed hole diameter	D ₂	0.5	13.00
Sprocket hole position	E	0.1	1.75
Punch hole position	F	0.1	5.50
Punch hole pitch	P	0.1	4.00
Sprocket hole pitch	P ₀	0.1	4.00
Embossment center	P ₁	0.1	2.00
Overall tape thickness	T	0.1	0.28
Tape width	W	0.3	12.00
Reel width	W ₁	1.0	18.00

Note: Devices are packed in accordance with EIA standard RS-481-A and specifications listed above.

Reel packing

PACKAGE	REEL SIZE	REEL (pcs)	COMPONENT SPACING (m/m)	BOX (pcs)	INNER BOX (m/m)	REEL DIA. (m/m)	CARTON SIZE (m/m)	CARTON (pcs)	APPROX. GROSS WEIGHT (kg)
SMA	7"	2,000	4.0	4,000	183*155*183	178	382*356*392	80,000	16.0
SMA	11"	5,000	4.0	10,000	290*290*38	330	310*310*360	80,000	11.0
SMA	13"	7,500	4.0	15,000	335*335*38	330	350*330*360	120,000	14.5

Suggested Pad Layout



Symbol	Unit (mm)	Unit (inch)
A	1.68	0.066
B	1.52	0.060
C	3.90	0.154
D	2.41	0.095
E	5.45	0.215

Important Notice and Disclaimer

Microdiode Electronics (Jiangsu) reserves the right to make changes to this document and its products and specifications at any time without notice. Customers should obtain and confirm the latest product information and specifications before final design, purchase or use.

Microdiode Electronics (Jiangsu) makes no warranty, representation or guarantee regarding the suitability of its products for any particular purpose, nor does Microdiode Electronics (Jiangsu) assume any liability for application assistance or customer product design. Microdiode Electronics (Jiangsu) does not warrant or accept any liability with products which are purchased or used for any unintended or unauthorized application.

No license is granted by implication or otherwise under any intellectual property rights of Microdiode Electronics (Jiangsu).

Microdiode Electronics (Jiangsu) products are not authorized for use as critical components in life support devices or systems without express written approval of Microdiode Electronics (Jiangsu).