



SL210BF

Reverse Voltage 100 Volts Forward Current - 2.0 Ampere

SURFACE MOUNT SCHOTTKY BARRIER RECTIFIER

Features

- ◆ Metal silicon junction, majority carrier conduction
- ◆ For surface mounted applications
- ◆ Low power loss, high efficiency
- ◆ High forward surge current capability
- ◆ For use in low voltage, high frequency inverters, free wheeling, and polarity protection applications

Mechanical Data

Case: JEDEC $\dot{U}T B\dot{O}$ molded plastic body
 Terminals: Solderable per MIL-STD-750, Method 2026A
 Polarity: Polarity symbol marking on body
 Mounting Position: Any
 Weight: 0.002 ounce, 0.057 grams

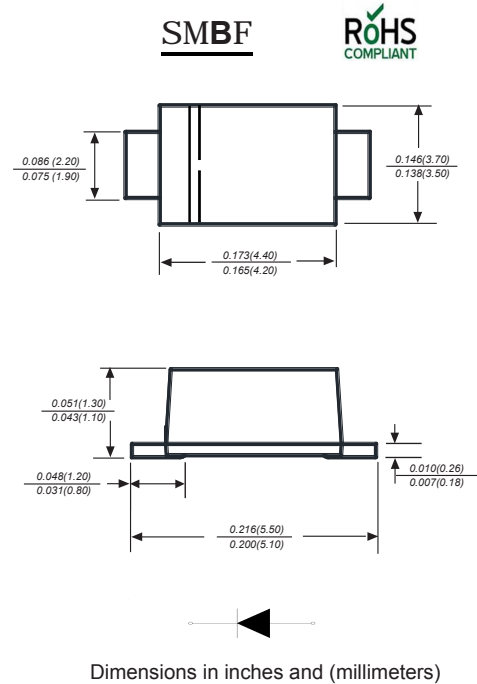

Maximum Ratings And Electrical Characteristics

Ratings at 25°C ambient temperature unless otherwise specified.
 Single phase half-wave 60Hz, resistive or inductive load, for capacitive load current derate by 20%.

Parameter	SYMBOLS	MDD SL210BF	UNITS
Marking Code			
Maximum repetitive peak reverse voltage	V_{RMM}	100	V
Maximum RMS voltage	V_{RMS}	70	V
Maximum DC blocking voltage	V_{DC}	100	V
Maximum average forward rectified current at $T_L=65^\circ C$	$I_{(AV)}$	2.0	A
Peak forward surge current 8.3ms single half sine-wave superimposed on rated load (JEDEC Method)	I_{FSM}	50	A
Maximum instantaneous forward voltage at 2.0A	V_F	0.7	V
Maximum DC reverse current $T_A=25^\circ C$ at rated DC blocking voltage $T_A=125^\circ C$	I_R	0.15 20.0	mA
Typical junction capacitance (NOTE 1)	C_J	100	pF
Typical thermal resistance (NOTE 2)	$R_{\theta JA}$	25.0	$^\circ C/W$
Operating storage temperature range	T_J	-50 to +125	$^\circ C$
Operating junction temperature range	T_{STG}	-50 to +150	$^\circ C$

Note: 1. Measured at 1MHz and applied reverse voltage of 4.0V D.C.
 2. P.C.B. mounted with 0.5x0.5" (12.7x12.7mm) copper pad areas



SL210BF

Reverse Voltage - 100 Volts Forward Current - 2.0 Ampere

Typical Characteristics

Fig.1 Forward Current Derating Curve

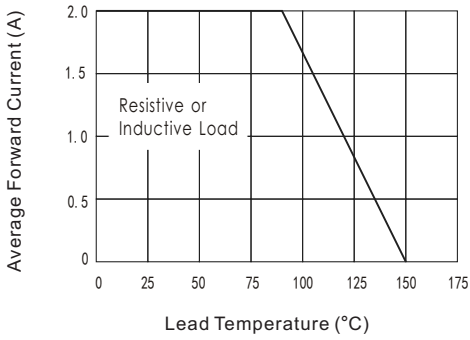

Fig.2 Typical Reverse Characteristics

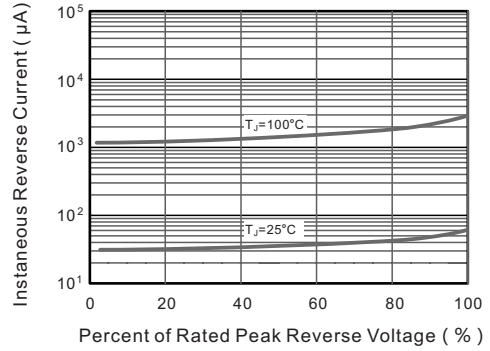

Fig.3 Typical Forward Characteristic

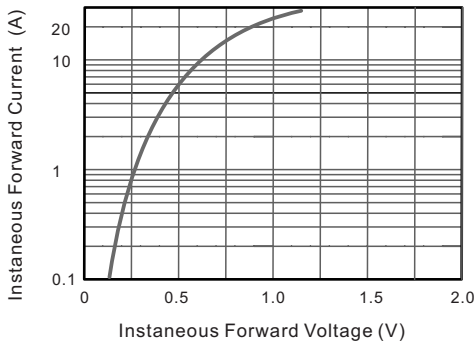

Fig.4 Typical Junction Capacitance

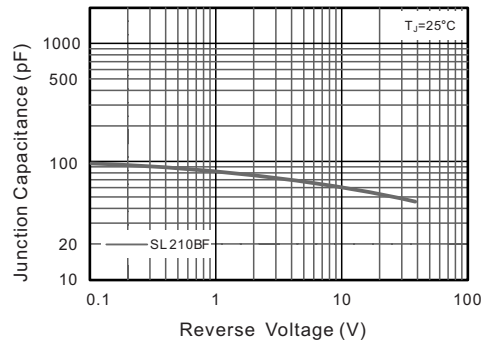

Fig.5 Maximum Non-Repetitive Peak Forward Surge Current

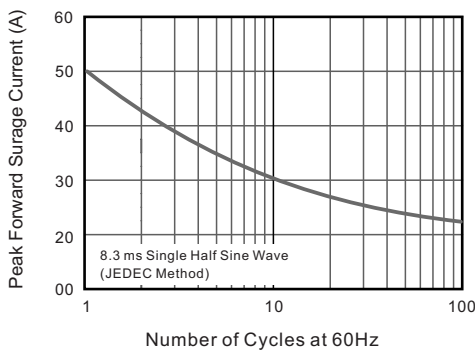
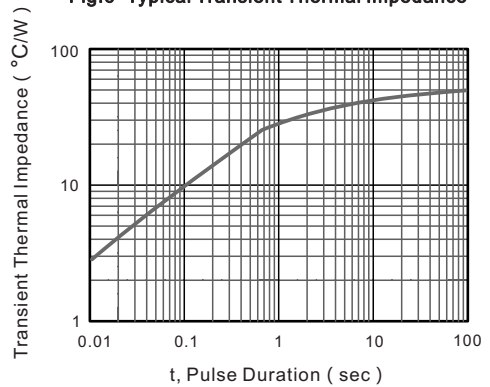

Fig.6- Typical Transient Thermal Impedance



The curve above is for reference only.



SL210BF

Reverse Voltage - 100 Volts Forward Current - 2.0 Ampere

Packing information

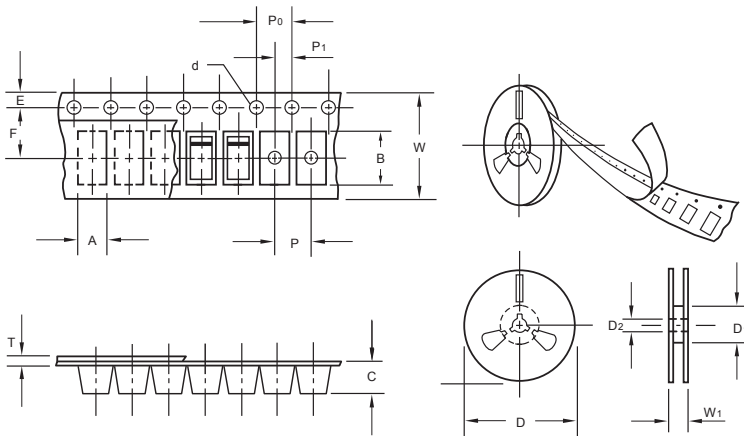

unit:mm

Item	Symbol	Tolerance	SMBF
Carrier width	A	0.1	3.81
Carrier length	B	0.1	5.61
Carrier depth	C	0.1	1.60
Sprocket hole	d	0.05	1.50
13" Reel outside diameter	D	2.0	330.00
13" Reel inner diameter	D ₁	min	50.00
Feed hole diameter	D ₂	0.5	13.00
Sprocket hole position	E	0.1	1.75
Punch hole position	F	0.1	5.50
Punch hole pitch	P	0.1	4.00
Sprocket hole pitch	P ₀	0.1	4.00
Embossment center	P ₁	0.1	2.00
Overall tape thickness	T	0.1	0.30
Tape width	W	0.3	12.00
Reel width	W ₁	1.0	12.30

Note: Devices are packed in accordance with EIA standard RS-481-A and specifications listed above.

Reel packing

PACKAGE	REEL SIZE	REEL (pcs)	COMPONENT SPACING (mm)	BOX (pcs)	INNER BOX (mm)	REEL DIA. (mm)	CARTON SIZE (mm)	CARTON (pcs)	APPROX. GROSS WEIGHT (kg)
SMBF	13"	5,000	4.0	10,000	190*190*41	330	365*365*360	80,000	14.0

Suggested Pad Layout



Symbol	Unit (mm)	Unit (inch)
A	2.54	0.100
B	1.8	0.071
C	4.8	0.189
D	3.0	0.118
E	6.6	0.260