



# SD101AW THRU SD101CW

Reverse Voltage 40-60 Volts Forward Current - 0.015 Ampere

## SCHOTTKY DIODES

### Features

- ◆ Fast switching speed
- ◆ Surface mount package ideally suited
- ◆ for automatic insertion
- ◆ Negligible reverse recovery time
- ◆ Guard ring construction for transient protection

SOD-123

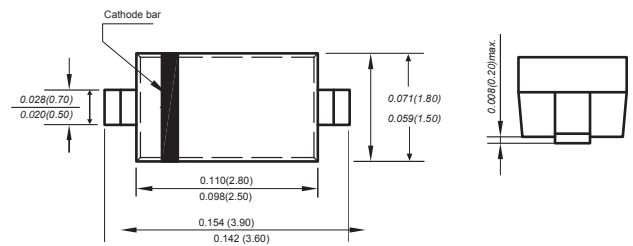

### Mechanical Data

Case: JEDEC SOD-123 molded plastic body  
 Terminals: Plated leads solderable per MIL-STD-750, Method 2026

Polarity: Polarity symbols marked on case

Weight: 0.0007 ounce, 0.02 grams

Marking: SD101AW:S1, SD101BW:S2, SD101CW:S3

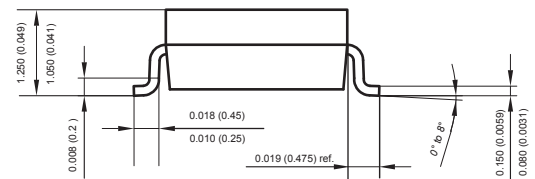

Dimensions in inches and (millimeters)

### Absolute Maximum Ratings at 25 °C

PARAMETER	SYMBOLS	SD101AW	SD101BW	SD101CW	UNITS
Peak repetitive peak reverse voltage	$V_{RRM}$				VOLTS
Working peak reverse voltage	$V_{RWM}$	60	50	40	
DC Blocking voltage	$V_{DC}$				
RMS Reverse voltage	$V_{R(RMS)}$	42	35	28	V
Forward continuous current	$I_{FM}$		15		mA
Repetitive peak forward current @ $t < 1.0s$	$I_{FRM}$		50		mA
@ $t = 10\mu s$			2.0		A
Power dissipation	$P_d$		400		mW
Thermal resistance junction to ambient	$R_{\theta JA}$		300		°C/W
Storage temperature	$T_{STG}$		-65 to +125		°C

### Characteristics at $T_a = 25\text{ °C}$

PARAMETER	SYMBOLS	Min.	Typ.	Max.	Unit	Conditions
Reverse breakdown voltage	$V_{(BR)R}$	60			V	$I_R = 10\mu A$ $I_R = 10\mu A$ $I_R = 10\mu A$
Forward voltage	$V_F$			0.41	V	$I_F = 1.0mA$ $I_F = 1.0mA$ $I_F = 1.0mA$ $I_F = 15mA$ $I_F = 15mA$ $I_F = 15mA$
Reverse current	$I_{RM}$			0.2	$\mu A$	$V_R = 50V$ $V_R = 40V$ $V_R = 30V$
Capacitance between terminals	$C_T$			2.0	pF	$V_R = 0V, f = 1.0MHz$
Reverse recovery time	$t_{rr}$			1.0	ns	$I_F = I_R = 5mA$ $I_{rr} = 0.1I_R, R_L = 100\ \Omega$



# SD101AW THRU SD101CW

Reverse Voltage 40-60 Volts Forward Current - 0.015 Ampere

## Typical Characteristics

FIG. 1- POWER DERATING CURVE

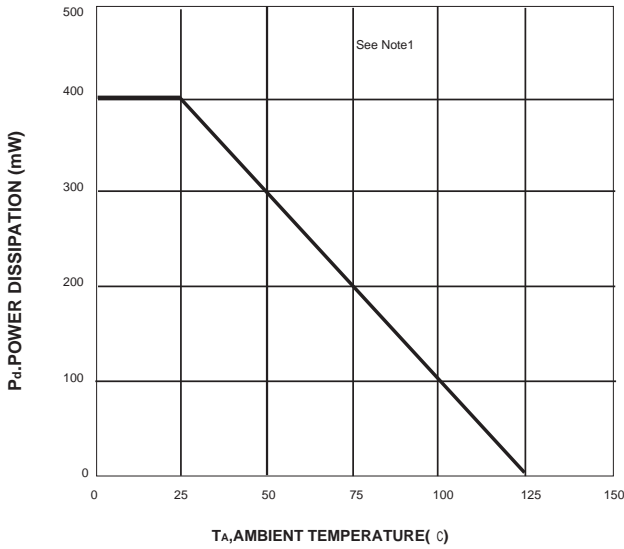

FIG. 2-TYPICAL FORWARD CHARACTERISTIC

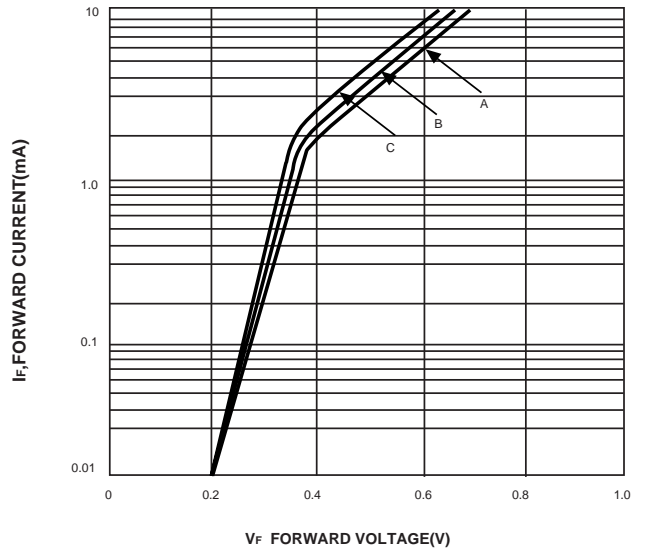

FIG.3- TYPICAL TOTAL CAPACITANCE VS REVERSE VOLTAGE

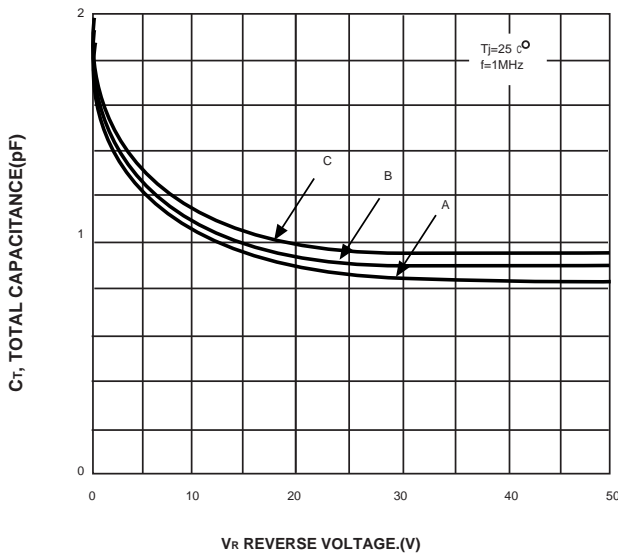
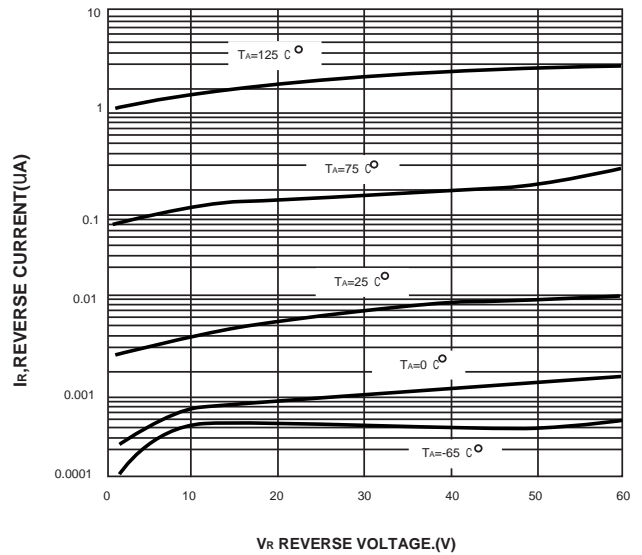

FIG. 4- TYPICAL REVERSE CHARACTERISTICS



The curve above is for reference only.



# SD101AW THRU SD101CW

Reverse Voltage 40-60 Volts Forward Current - 0.015 Ampere

## Packing information

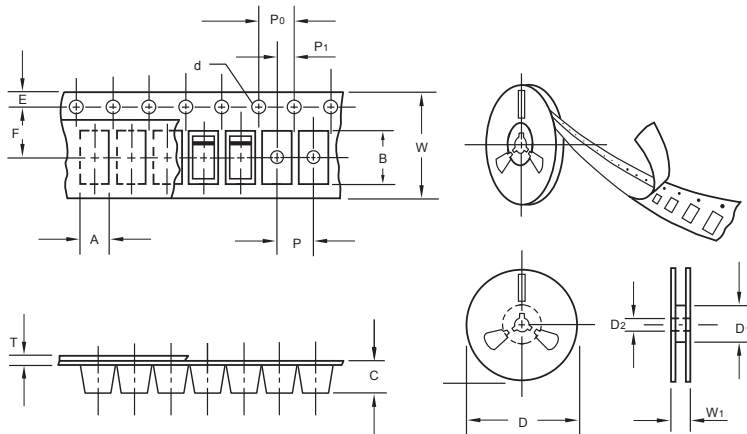

unit:mm

Item	Symbol	Tolerance	SOD-123
Carrier width	A	0.1	2.1
Carrier length	B	0.1	4.0
Carrier depth	C	0.1	1.60
Sprocket hole	d	0.05	1.55
7" Reel outside diameter	D	2.0	178.00
7" Reel inner diameter	D <sub>1</sub>	min	50.0
Feed hole diameter	D <sub>2</sub>	0.5	13.00
Sprocket hole position	E	0.1	1.75
Punch hole position	F	0.1	3.50
Punch hole pitch	P	0.1	4.00
Sprocket hole pitch	P <sub>0</sub>	0.1	4.00
Embossment center	P <sub>1</sub>	0.1	2.00
Overall tape thickness	T	0.1	0.25
Tape width	W	0.3	8.15
Reel width	W <sub>1</sub>	1.0	10.5

Note: Devices are packed in accordance with EIA standard RS-481-A and specifications listed above.

## Reel packing

PACKAGE	REEL SIZE	REEL (pcs)	COMPONENT SPACING (m/m)	BOX (pcs)	INNER BOX (m/m)	REEL DIA, (m/m)	CARTON SIZE (m/m)	CARTON (pcs)	APPROX. GROSS WEIGHT (kg)
SOD-123	7"	3,000	4.0	45,000	210*208*203	178	430*430*235	180,000	9.0

## Suggested Pad Layout

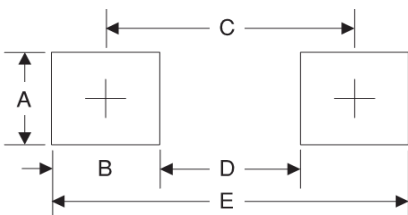

Symbol	Unit (mm)	Unit (inch)
A	1.2	0.047
B	1.2	0.047
C	3.2	0.126
D	2.0	0.079
E	4.4	0.173