

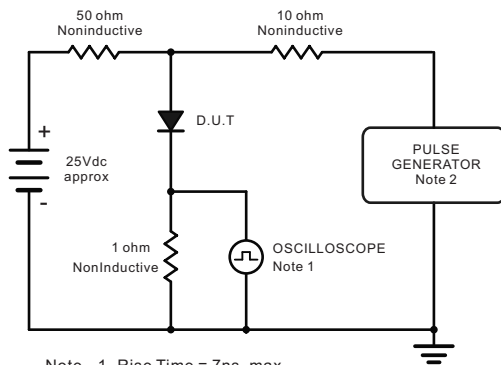

ES5ABG THRU ES5JBG

Reverse Voltage - 50 to 600 Volts Forward Current - 5.0 Ampere

Ratings And Characteristic Curves



Note: 1. Rise Time = 7ns, max.
Input Impedance = 1megohm, 22pF.
2. Rise Time = 10ns, max.
Source Impedance = 50 ohms.

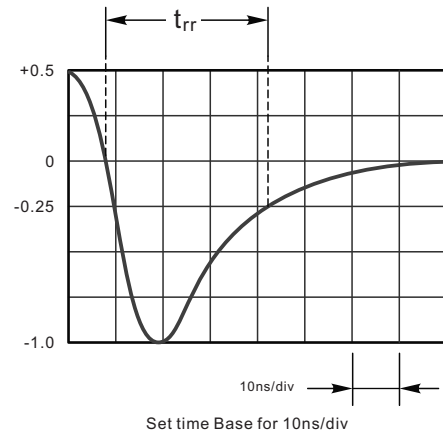

Fig.2 Maximum Average Forward Current Rating

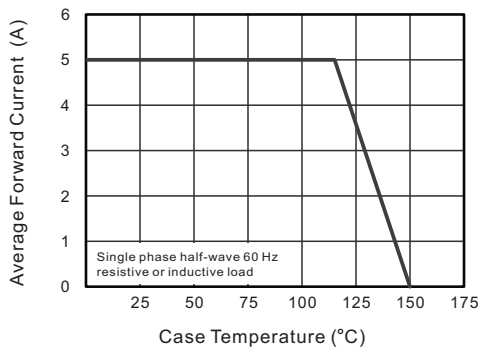

Fig.3 Typical Reverse Characteristics

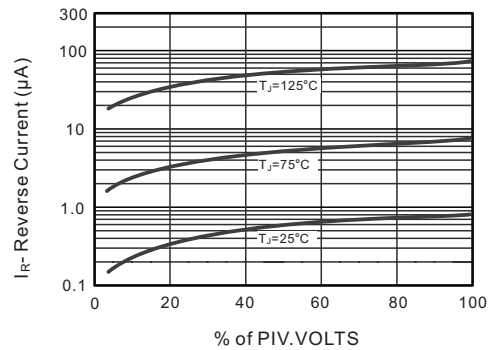

Fig.4 Typical Forward Characteristics

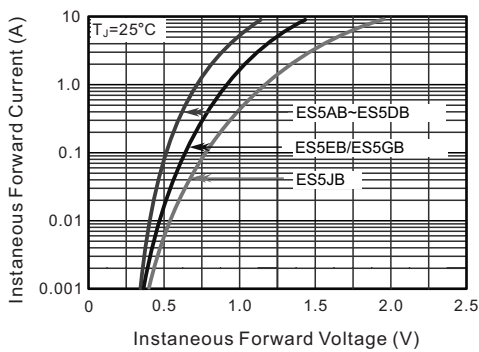

Fig.5 Typical Junction Capacitance

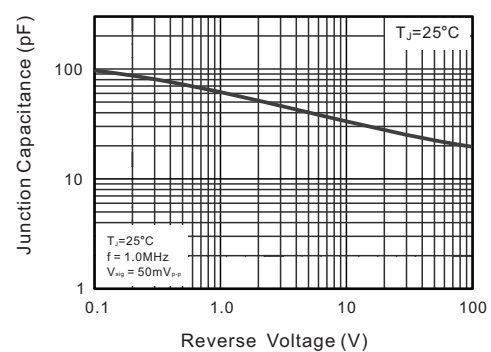
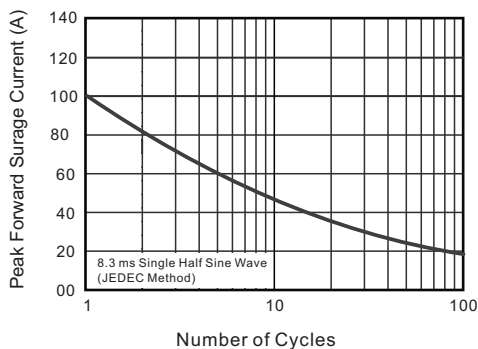

Fig.6 Maximum Non-Repetitive Peak Forward Surge Current



The curve above is for reference only.



ES5ABG THRU ES5JBG

Reverse Voltage - 50 to 600 Volts Forward Current - 5.0 Ampere

Packing information



unit:mm

Item	Symbol	Tolerance	SMC
Carrier width	A	0.1	6.15
Carrier length	B	0.1	8.41
Carrier depth	C	0.1	2.42
Sprocket hole	d	0.05	1.50
13" Reel outside diameter	D	2.0	330.00
13" Reel inner diameter	D1	min	50.00
Feed hole diameter	D2	0.5	13.00
Sprocket hole position	E	0.1	1.75
Punch hole position	F	0.1	7.50
Punch hole pitch	P	0.1	8.00
Sprocket hole pitch	P0	0.1	4.00
Embossment center	P1	0.1	2.00
Overall tape thickness	T	0.1	0.25
Tape width	W	0.3	16.00
Reel width	W1	1.0	16.50

Note: Devices are packed in accordance with EIA standard RS-481-A and specifications listed above.

Reel packing

PACKAGE	REEL SIZE	REEL (pcs)	COMPONENT SPACING (mm)	BOX (pcs)	INNER BOX (mm)	REEL DIA, (mm)	CARTON SIZE (mm)	CARTON (pcs)	APPROX. GROSS WEIGHT (kg)
SMC	13"	3,000	4.0	6000	190*190*41	330	365*365*340	42000	14.0

Suggested Pad Layout



Symbol	Unit (mm)	Unit (inch)
A	4.3	0.170
B	4.1	0.160
C	7.9	0.311
D	3.8	0.150
E	12	0.472

Important Notice and Disclaimer

Microdiode Electronics (Jiangsu) reserves the right to make changes to this document and its products and specifications at any time without notice. Customers should obtain and confirm the latest product information and specifications before final design, purchase or use.

Microdiode Electronics (Jiangsu) makes no warranty, representation or guarantee regarding the suitability of its products for any particular purpose, nor does Microdiode Electronics (Jiangsu) assume any liability for application assistance or customer product design. Microdiode Electronics (Jiangsu) does not warrant or accept any liability with products which are purchased or used for any unintended or unauthorized application.

No license is granted by implication or otherwise under any intellectual property rights of Microdiode Electronics (Jiangsu).

Microdiode Electronics (Jiangsu) products are not authorized for use as critical components in life support devices or systems without express written approval of Microdiode Electronics (Jiangsu).