



DSL22 THRU DSL210

Reverse Voltage - 20 to 100 Volts Forward Current - 2.0 Ampere

SURFACE MOUNT SCHOTTKY BARRIER RECTIFIER

Features

- ◆ The plastic package carries Underwriters Laboratory Flammability Classification 94V-0
- ◆ For surface mounted applications
- ◆ Metal silicon junction, majority carrier conduction
- ◆ Low power loss, high efficiency
- ◆ Built-in strain relief, ideal for automated placement
- ◆ High forward surge current capability
- ◆ High temperature soldering guaranteed:
250 °C/10 seconds at terminals

SOD-123FL

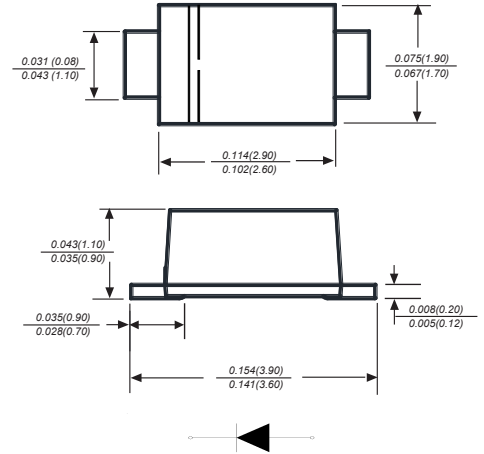

Dimensions in inches and (millimeters)

Mechanical Data

Case: JEDEC SOD-123FL molded plastic body
 Terminals: Solderable per MIL-STD-750, Method 2026
 Polarity: Color band denotes cathode end
 Mounting Position: Any
 Weight: 0.0007 ounce, 0.02 grams

Maximum Ratings And Electrical Characteristics

Ratings at 25 °C ambient temperature unless otherwise specified.

Single phase half-wave 60Hz, resistive or inductive load, for capacitive load current derate by 20%.

Parameter	SYMBOLS	MDD DSL22	MDD DSL23	MDD DSL24	MDD DSL25	MDD DSL26	MDD DSL27	MDD DSL28	MDD DSL29	MDD DSL210	UNITS
Marking Code											
Maximum repetitive peak reverse voltage	V_{RRM}	20	30	40	50	60	70	80	90	100	V
Maximum RMS voltage	V_{RMS}	14	21	28	35	42	49	56	63	70	V
Maximum DC blocking voltage	V_{DC}	20	30	40	50	60	70	80	90	100	V
Maximum average forward rectified current at TL (see fig. 1)	$I_{(AV)}$	2.0									A
Peak forward surge current 8.3ms single half sine-wave superimposed on rated load (JEDEC Method)	I_{FSM}	40									A
Maximum instantaneous forward voltage at 2.0A	V_F	0.45		0.50			0.70			V	
Maximum DC reverse current $T_A=25^\circ\text{C}$ at rated DC blocking voltage $T_A=125^\circ\text{C}$	I_R	0.5						0.2			mA
		10.0						5.0			
Typical junction capacitance (NOTE 1)	C_J	110			80						pF
Typical thermal resistance (NOTE 2)	$R_{\theta JA}$	95.0									°C/W
Operating junction temperature range	T_J	-55 to +125						-55 to +150			°C
Storage temperature range	T_{STG}	-55 to +150									°C

Note: 1. Measured at 1MHz and applied reverse voltage of 4.0V D.C.

2. PCB mounted on 0.2*0.2" (5.0*5.0mm) copper pad area.



Typical Characteristics

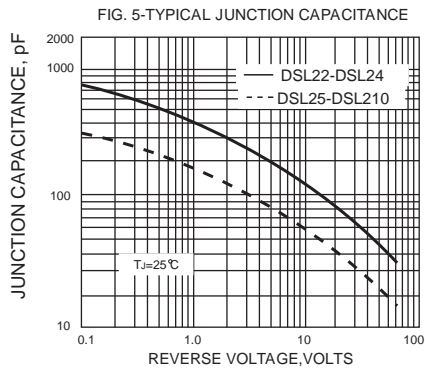
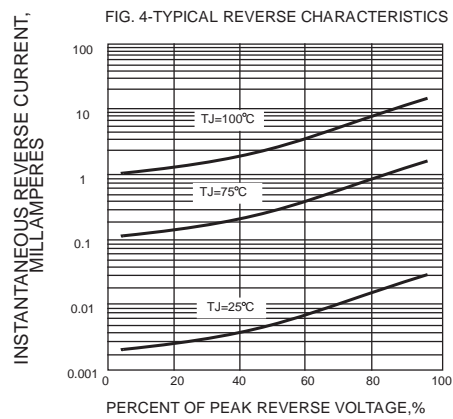
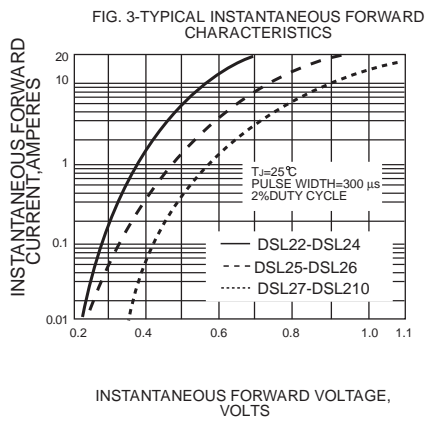
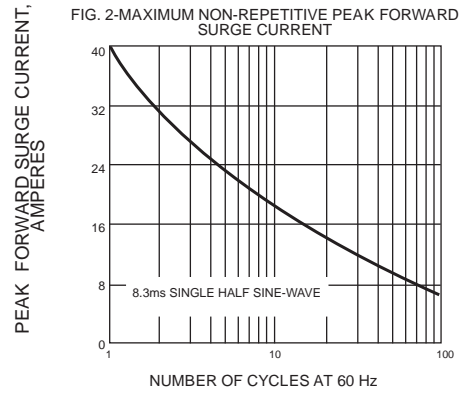
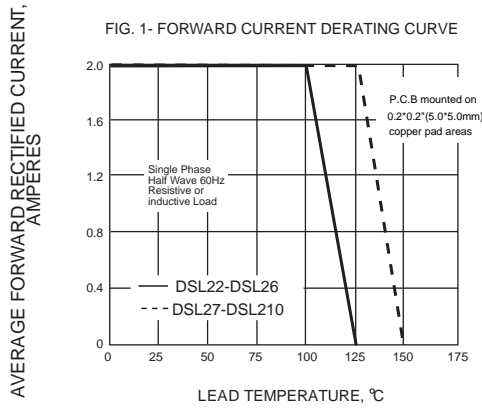

The curve above is for reference only.



DSL22 THRU DSL210

Reverse Voltage - 20 to 100 Volts Forward Current - 2.0 Ampere

Packing information

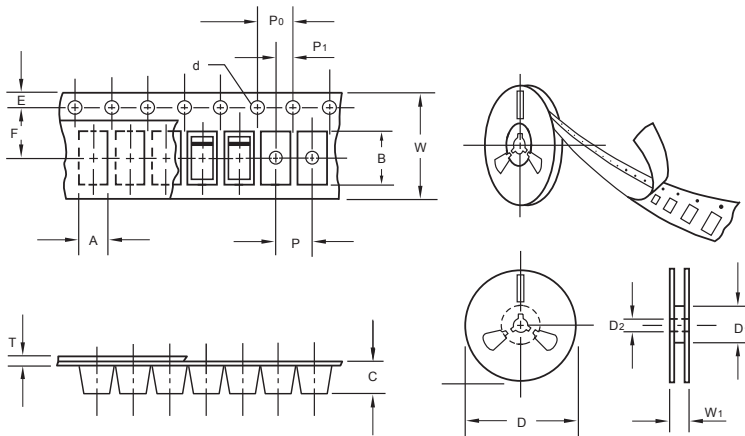

unit:mm

Item	Symbol	Tolerance	SOD-123FL
Carrier width	A	0.1	2.1
Carrier length	B	0.1	4.0
Carrier depth	C	0.1	1.60
Sprocket hole	d	0.05	1.55
7" Reel outside diameter	D	2.0	178.00
7" Reel inner diameter	D1	min	50.0
Feed hole diameter	D2	0.5	13.00
Sprocket hole position	E	0.1	1.75
Punch hole position	F	0.1	3.50
Punch hole pitch	P	0.1	4.00
Sprocket hole pitch	P0	0.1	4.00
Embossment center	P1	0.1	2.00
Overall tape thickness	T	0.1	0.25
Tape width	W	0.3	8.15
Reel width	W1	1.0	10.5

Note: Devices are packed in accordance with EIA standard RS-481-A and specifications listed above.

Reel packing

PACKAGE	REEL SIZE	REEL (pcs)	COMPONENT SPACING (m/m)	BOX (pcs)	INNER BOX (m/m)	REEL DIA, (m/m)	CARTON SIZE (m/m)	CARTON (pcs)	APPROX. GROSS WEIGHT (kg)
SOD-123FL	7"	3,000	4.0	45,000	210*208*203	178	430*430*235	180,000	9.0

Suggested Pad Layout

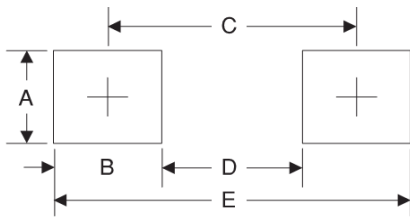

Symbol	Unit (mm)	Unit (inch)
A	1.2	0.047
B	1.2	0.047
C	3.2	0.126
D	2	0.079
E	4.4	0.173